

# North Star Ice Equipment



Ice Rakes  
and  
Delivery  
Systems

*North Star*

# Rectangular Ice Rake Systems

(CONFIGURATION R-2 SHOWN)

North Star rectangular ice rake systems are ideal for operations that require large storage capacities or where ice consumption varies greatly from day to day. Rectangular bins hold up to 250 U.S. tons of ice and offer the greatest capacity per unit of floor area.

The control panel integrates starter and logic controls for the ice maker, rake and delivery system. Other components can be added as well.

The hoist automatically adjusts the height of the rake to level the ice in the bin.

North Star's patented ice rake levels the ice as it is produced and discharges it on demand.

The motorized bin door opens and closes automatically for each discharge cycle.

Twin screws carry the ice to the delivery system.

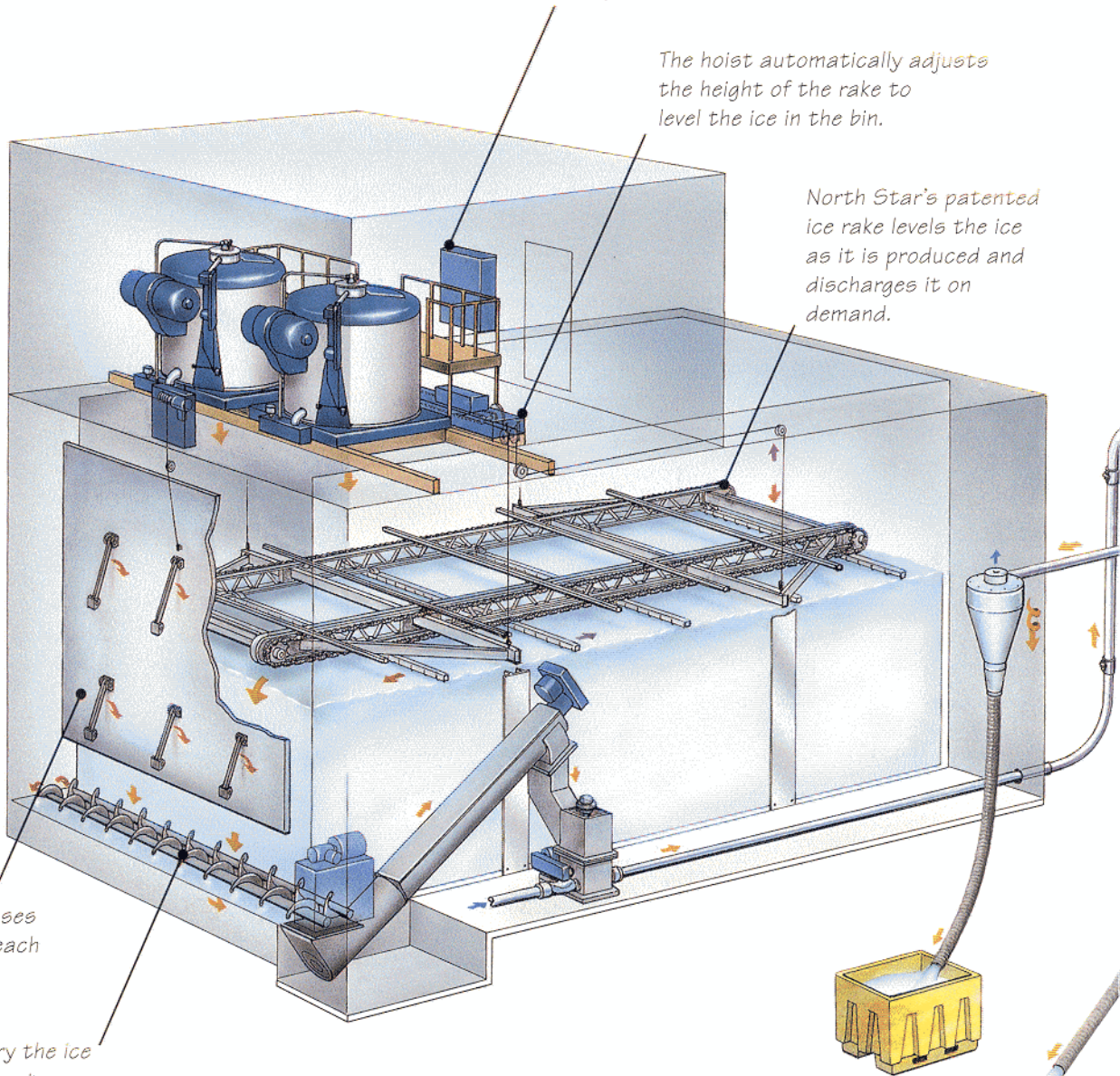

## Rectangular Rake Specifications

Model	Maximum Interior Bin Dimensions			Storage Capacity
	Width	Length	Height	
15"	18 ft. (5490 mm)	36 ft. (10980 mm)	14 ft. (4270 mm)	100 tons (91 MT)
17"	20 ft. (6100 mm)	52 ft. (15850 mm)	14 ft. (4270 mm)	165 tons (150 MT)
17"S	22 ft. (6710 mm)	57 ft. (17380 mm)	14 ft. (4270 mm)	200 tons (182 MT)
17"SD	25 ft. (7620 mm)	62 ft. (18900 mm)	14 ft. (4270 mm)	250 tons (227 MT)

A pneumatic system delivers large volumes of ice to multiple use points over long distances. Screw conveyor systems are also available.

# North Star<sup>®</sup>

## Ice Delivery Systems

Rectangular and triangular ice rakes can be equipped with either screw conveyor or pneumatic delivery systems for automatic delivery to remote icing stations. Up to 40 tons of ice per hour can be delivered to single or multiple use points.

### Screw Conveyor Systems

- Most economical for horizontal deliveries of up to approximately 150 feet.
- Can be installed at angles up to 30 degrees from horizontal.
- Manual or automatic curved slide gates provide intermediate in-line discharge points.
- Available in either galvanized finish or stainless steel, with or without factory-applied insulation.

### Pneumatic Delivery Systems

- Most economical when conveying ice over long distances, when multiple icing stations are required, or when the ice must be elevated.
- Manual or automatic diverter valves provide multiple delivery points.
- Provides high velocity discharge to trucks, boats or railcars; gravity discharge using a cyclone receiver for totes, case icers or day tanks.

*NOTES: The illustrations on this page represent two possible ice plant configurations. Other bin configurations can be designed to meet your specific application. (See chart to right.) Contact North Star for more information.*

*Storage capacities are based on a 8-foot (2440 mm) ice depth for model 12" and a 10-foot (3050 mm) ice depth for model 15" and all 17" models. One U.S. ton equals approximately 60 cubic feet of ice. One metric ton equals 1.87 cubic meters of ice. Bins can be combined for greater capacity.*

*Specifications subject to change without notice.*



**Seafood Produce**  
**Meat Poultry Bakery**  
**Grocery Chemical Concrete**  
**Snow Making**

# Triangular Ice Rake Systems

(CONFIGURATION T-1 SHOWN)

North Star triangular ice rake systems are most economical for storage of ice up to 55 U.S. tons. The triangular rake system discharges the ice at an elevated point for direct delivery into carts or an external conveyor system. The triangular system is ideal for plants where ice is used throughout a 24-hour day and therefore a large storage capacity is not required.

Control panels can be designed to accommodate dual rake systems, multiple ice makers or other design options.

Multiple ice makers can be installed to increase production.

The hoist raises and lowers only the idle end of the ice rake.

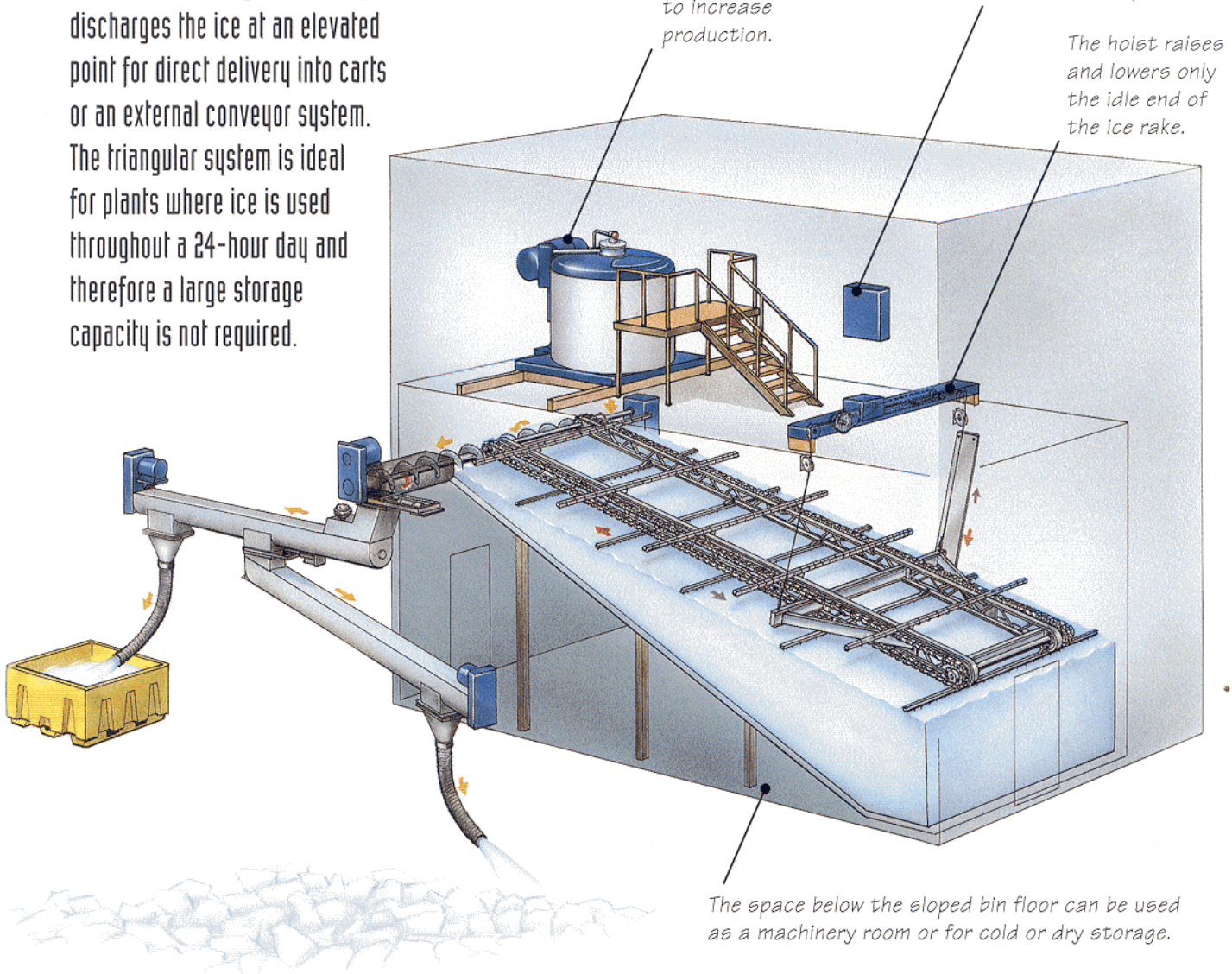

The space below the sloped bin floor can be used as a machinery room or for cold or dry storage.

A single screw discharges the ice above floor level directly to totes or carts, or to a screw conveyor or pneumatic delivery system.

## Triangular Rake Specifications

Model	Maximum Interior Bin Dimensions			Storage Capacity
	Width	Length	Height	
12'	8 ft. (2440 mm)	22 ft. (6710 mm)	12 ft. (3660 mm)	12 tons (11 MT)
15'	14 ft. (4270 mm)	30 ft. (9150 mm)	14 ft. (4270 mm)	35 tons (32 MT)
17'	16 ft. (4880 mm)	42 ft. (12810 mm)	14 ft. (4270 mm)	55 tons (50 MT)

# North Star

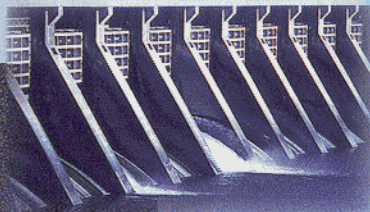

## North Star Ice Systems

### The Most Efficient Way to Produce, Store and Deliver Ice

North Star Ice Equipment, the world leader in flake ice technology, manufactures automatic ice systems designed to produce, store and deliver ice all at the touch of a button. Versatile enough for any industrial application, North Star ice systems are custom designed for each client, and offer a convenient and economical way to handle ice. North Star's proven design and expert construction result in an ice system that is easy to install and built to last.



# Custom Designed to Meet Your Needs

*Each North Star ice system is composed of three elements: the ice maker, ice rake, and delivery system. North Star combines these elements in a custom design to meet your specific ice production, storage and delivery requirements. At the heart of the system is North Star's patented ice rake. The rake handles any type of ice — leveling it in the bin to maximize storage space and automatically discharging ice when it is needed. North Star ice rakes have long been proven the most efficient and dependable way to handle ice.*

## Bin Configurations

### Rectangular Systems

R-1: Bin at ground level with an internal elevating conveyor.

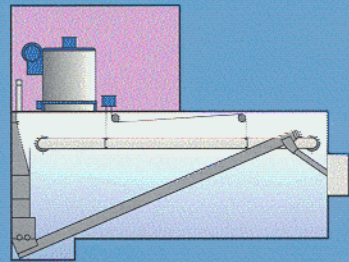

R-2: Bin with pneumatic conveying system.

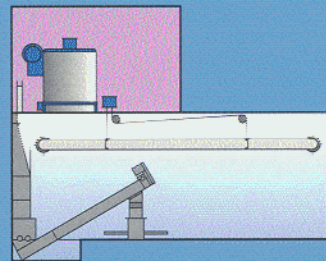

R-3: Elevated bin with direct discharge from twin screws through a slide gate.

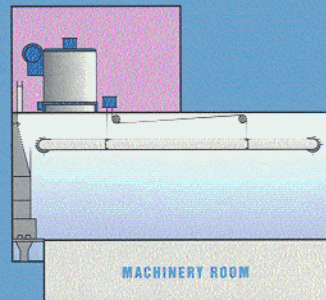

### Triangular Systems

T-1: Bin with direct discharge or discharge to an external screw conveyor.

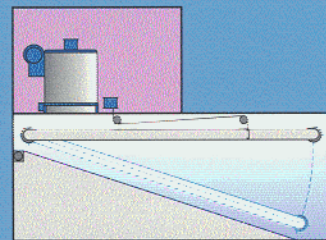

T-2: Bin with pneumatic conveying system.

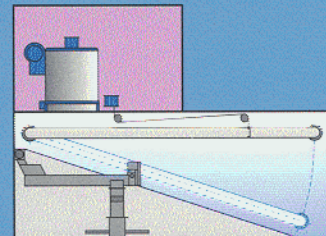

## Special Equipment

North Star can also provide additional equipment for special handling or delivery applications, including equipment for intermediate storage and metered delivery.

Pre-Fabricated Bins	Ice Dispensers	Day Tanks	Ice Slingers	Ice Metering	Control Panels	Computer Monitoring and Control
Insulated panels with simple latching devices lock together quickly to form the ice bin and penthouse.	Case ice dispensers hold from 1,500 to 2000 pounds of ice and automatically deliver it to cases in convenient pre-set amounts.	Galvanized tanks with optional insulated hopper provide intermediate storage of two to three tons of ice.	Mechanical slingers throw ice at high velocity into hard to reach areas, such as the hold of a boat or the front of a trailer.	Volumetric metering of ice delivery within $\pm 2\%$ accuracy.	Options include Type B wiring with short circuit protection, variable speed hoist drive and enhanced operator interface with alarm messaging.	Remote modem or on-site monitoring and control via computer.

## North Star: The World Leader In Flake Ice Technology

Since 1950, North Star Ice Equipment Corporation has been known the world over for its line of flake ice makers and ice handling systems. The company's product line includes ice rakes and storage systems, ice delivery systems, containerized ice plants and other related products. North Star ice systems are now operating in over 90 countries in a wide variety of applications.

### Seafood

Fishing, aquaculture, at-sea and land-based processing, holding, transportation and display

### Produce

Perishable cooling and transport

### Packaged Ice

Ice storage and delivery

### Meat & Poultry

Processing and value-added products

### Bakery

Dough cooling

### Chemical

Dye and chemical manufacturing

### Construction

Concrete cooling

### Grocery

Perishable food holding and display

### Recreation

Ski resort snow-making

North Star Ice Equipment Corporation  
P.O. Box 80227 • 8151 Occidental Ave. S.  
Seattle, WA 98108-0227 USA  
Telephone: (206) 763-7300  
Toll-free in USA: 1-800-321-1381  
Fax: (206) 763-7323  
E-mail: [info@northstarice.com](mailto:info@northstarice.com)  
Web Site: [www.northstarice.com](http://www.northstarice.com)